

Slot.it[®]



slot
CARS
ACCESSORIES
1:32·SCALE



slot.it

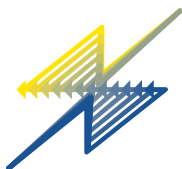

Galileo Engineering

Progettazione elettronica

Galileo Engineering srl
via Cavallotti 16
42122 Reggio Emilia, Italy
Tel (+039) 0522 920496
Tel (+039) 0522 516244
Fax (+039) 0522 920496
E-mail: info@slot.it



Release January 2020



slot.it

INDEX

4	HRS2 Ready to run
6	HRS2 Starter kit
8	HRS2 Spare parts
11	Chassis spares
12	LMP Pickups
13	Cable/Braids/Terminals
14	Pickups
16	Motor configuration
18	Motor mounts
26	4WD System
28	Motors
32	Pinions
35	Extractor/Press
38	Sidewinder Spur Gears
39	Inline Crown Gears
42	Modular crown
44	Anglewinder Gears
48	Starter Kit
50	Wheels
55	Axle and Spacer
56	Plastic inserts
62	Tyres
64	Bushing & Pulleys
64	Suspensions
65	Magnets & Ballast
66	Screwdrivers
66	Screws
68	Cars spare parts
70	3D Print Shop
71	Vacuum forming cockpits
72	Electronic Controller SCP-3
74	Electronic Controller SCP-2
76	Analog controller SCP-2
77	Electronic Controller Spare parts
78	Analog controller SCP-2
79	Digital controller SCP-3
80	oXigen digital system
84	Lighting kit
86	Live Timing System
88	Prints & Posters
89	Maintenance
89	Packaging
90	Distributors



HRS² Chassis

The HRS chassis is a fully configurable, universal plastic chassis for slot cars. It comprises four main parts: main chassis, front chassis, motor mount, and body mounting means.

ADJUSTABLE WHEELBASE

The front chassis can be positioned freely within a wheelbase between 64 and 90 mm.

SELECTABLE FRONT AXLE POSITION

The front axle can be placed in one of two possible positions, one of which completely adjustable, making it easy to adjust the distance from the pickup.

FLEXIBLE ASSEMBLY SYSTEM

The chassis and the body can be joined with either four mounting posts and cups (HRS1 style), two three-posts sidebars, or, on some cars, where possible, with the car's own screw holes.

4

HRS² Ready to run



CH109d

Inline HRS2

Ready to run HRS2 chassis

OFFSET 0.5 mm

19 mm $\odot \leftrightarrow \odot$ 64/90 mm $\square \leftrightarrow \square$ 56/61 mm



Ready to run

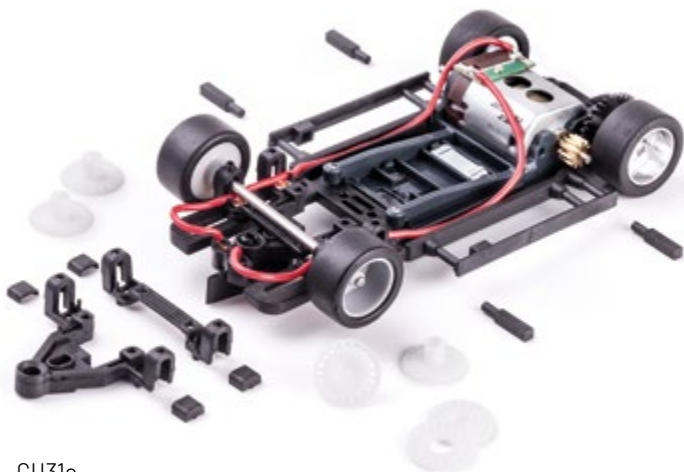

CH31c

Sidewinder HRS2

Ready to run HRS2 chassis

OFFSET 0.5 mm

19 mm 64/90 mm 57/61 mm

5



CH32d

Anglewinder HRS2

Ready to run HRS2 chassis

OFFSET 1.0 mm

19 mm 64/90 mm 60.6/64 mm



Starter kit



CH34b

Inline HRS2

Chassis starter kit

OFFSET: 0.0 mm

6



CH33b

Sidewinder HRS2

Chassis starter kit

OFFSET: 0.5 mm



Starter kit



CH35

Anglewinder HRS2

Chassis starter kit

OFFSET: 0.0 mm

7



CH36

Chassis-to-body HRS2

connecting cups and spare parts



Spare parts



CH37

Main Inline/ Sidewinder HRS2

Chassis



CH38

Main Anglewinder HRS2

Chassis

8

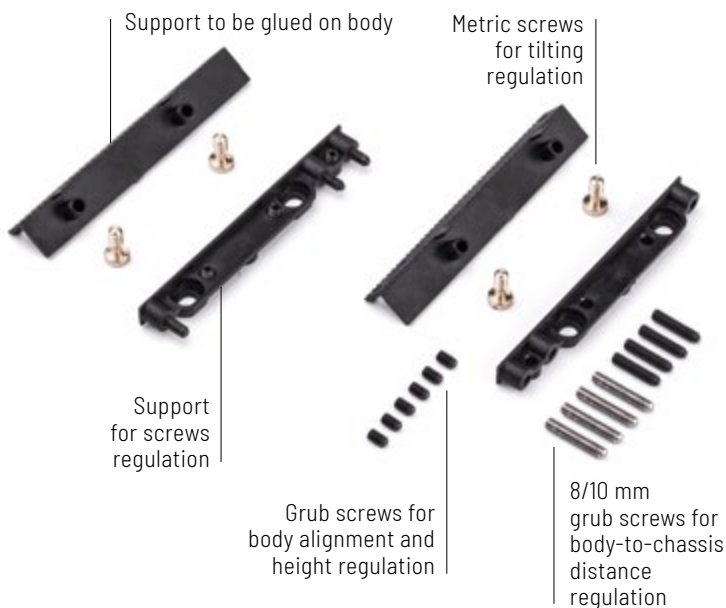

CH57b

Body-to-chassis HRS2 adapter

HRS² Spare parts



CH42

Chassis-to-body HRS2

connecting cups - (4x + 2x)

9



CH20

HRS Body to chassis adaptor cups - (4x)



HRS² Spare parts



10



CH50
SCX digital adapter for HRS2
chassis



CH50p
Replacement plastic parts for SCX digital

Chassis spares



SP07

Interchangeable spacers

for front axle regulation (2+2+2+2)



CH79b

Chassis common parts

11



CH72

Plastic retainer nuts (6x)

USE WITH CH51
SCREWS



LMP Pickups



CH88b

LMP screw racing pickup rev. C Standard Slot.it LMP models



CH111

LMP screw racing pickup for 4WD system



CH112

LMP screw racing pickup for wooden track



CH84b

LMP screw pickup for wooden track

Cable/Braids/Terminals

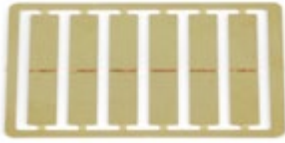

SP37
LMP pre-cut brass tabs
for pickup



SP22b
Silicon cable high flexibility
(1m)



SP29
LMP copper braid - (8x)

13



SP04
Brass terminal
ø 1.5 L4 mm (10x)
motor cable and independent
front wheels axle



SP17
Brass terminals
ø 1.6 L5 mm (10x)



SP19
Copper braid (1m)



SP18
Tin plated copper braid (1m)

Pickups



CH66
Clip racing pickup rev. B
Standard Slot.it models



CH26
Clip racing pickup
Old standard Slot.it models



CH10
Screw universal Pickup



CH07
Screw pickup for wooden track



14
CH85
Screw racing pickup
for standard Slot.it models



CH17
Clip short shaft pickup

CH06
Clip long shaft pickup





DEKRA
18

Diebels - ZAKSPEED-Team

diebels
Alt

diebels Alt

AMG

Diebels Alt

BOSCH

ZAKSPEED

Shell

BAUMLER
men's fashion

MICHELIN

Motor configuration

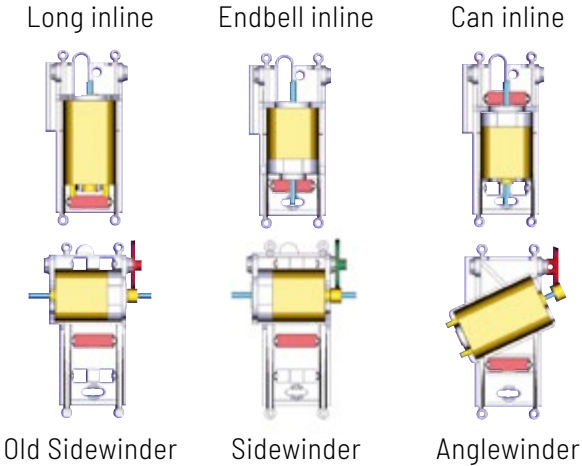

16

The Slot.it motor mounts allow easy installation of short and long can type motors configured as inline, sidwinder, or anglewinder. The 'offset' concept enables upwar-ds displacement of the rear shaft with regards to the bottom plane of the chassis and to the motor drive shaft, thus lowering the stance of the back of the car, to fine tune the ground clearance depending on type of track, wheels, tyres and motor, and desired model behaviour.

'Offset' is the vertical displacement, in mm, between the centres of the rear axle and of the motor shaft.

A further advantage of the 'Offset' principle is that the rear wheel can be properly positioned, vertically, inside the wheel arch of the bodywork.

In the '0.0' versions the motor shaft and the rear axle lie on the same plane, whereas in the 'offset' versions, unique to Slot.it, the rear axle is offset upwards, thus lowering the center of gravity of the car and increasing the magnetic traction which either the car magnet or the motor exert on the track.

Available offset motor mounts range from 0.0 to 1mm, depending on the selected motor mount type.

Another unique feature of the Slot.it motor mount are the self-aligning gimbal bushings. Traditional cylindric bushings cannot compensate for chassis torsion and bad alignment; Slot.it spherical bushing self adjust themselves to gua-rantee the minimum possible friction and can be made with optimal tole-rances to eliminate excessive play.

Motor configuration

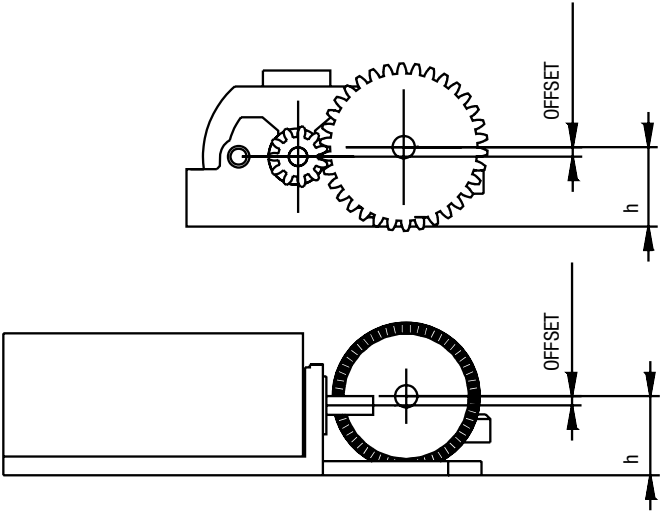

Offset Description				
OFFSET (mm)	h (mm)	ITEMS		
0.0	7.5	CH13c CH48 CH34b	CH61 CH76 KK11 CH35	CH48b CH117
0.5	8.0	CH31c CH33b CH60b	CH67 CH70 CH75 KK13b	CH109 CH110 CH114 CH118
0.75	8.25	CH68	CH69	
1.0	8.5	CH24b CH32c CH49b CH65	CH74 CH82 KK10b KK12b KK14c	KK16 CH115 CH119

Motor mounts

Box Stock Slot.it models

Classic



CH67

Classic

Slot.it models (2011 - 20xx)

OFFSET 0.5 mm

18

GT/ LMP



CH74

GT - LMP

Slot.it models (2012 - 20xx)

OFFSET 1.0 mm

Motor mounts

Box Stock Slot.it models

Classic DTM



19

Group C



CH110

Classic DTM

Slot.it models (2016 - 20xx) DTM

Slot.it models (2019 - 20xx) Gr. C

OFFSET 0.5 mm

Motor mounts

OFFSET 0.0 mm



CH61 > **HARD**

CH76 > **MEDIUM**

Anglewinder for Boxer / Flat-6 motors



CH117

Anglewinder

for Boxer / Flat-6 motors - bearing version

To use in conjunction with CH105 bearings



CH13c

Group C Slot.it models (2003 - 2012)



CH48b

Long inline for Boxer/Flat motors

Motor mounts

OFFSET 0.5 mm



CH60b > **HARD**
CH75 > **MEDIUM**
Anglewinder for Boxer / Flat-6 motors



CH118
Anglewinder
for Boxer / Flat-6 motors - bearing version
To use in conjunction with CH105 bearings



CH110
Classic DTM Slot.it models (2016 - 20xx)

BOX STOCK PART
SEE PAGE 17



CH114
Long inline for Boxer/Flat motors

Motor mounts

OFFSET 0.5 mm

BOX STOCK PART
SEE PAGE 18



CH67
Sidewinder for V12 motors

Motor mounts

OFFSET 0.75 mm

22



CH68
Sidewinder for V12 motors



CH69
Sidewinder for V12 motors

Motor mounts

OFFSET 1.0 mm



CH74 > **MEDIUM** BOX STOCK PART > SEE PAGE 18
GT - LMP Slot.it models (2012 - 20xx)

CH82 > **HARD**
Anglewriter for Boxer / Flat-6 motors



CH119
Anglewriter
for Boxer / Flat-6 motors - bearing version
To use in conjunction with CH105 bearings

23



CH65
Sidewriter for V12 motors



CH115
Sidewriter for V12 motors - bearing version
To use in conjunction with CH105 bearings

Motor mounts

OFFSET 1.0 mm



CH49b
Long inline for Boxer/Flat motors



CH24c
Inline reverse motor mount

24 Conversion Kit OFFSET 0.0 mm



KK11
Anglewinder Conversion Kit
Z30 AW Crowns + Z11 Ø 6.5 mm Pinion

Conversion Kit OFFSET 0.5 mm



KK13b
Sidewinder Conversion Kit
Z34 Ø 18 SW Crowns + Z11 Ø 6.5 mm Pinion

Motor mounts

Conversion Kit OFFSET 1.0 mm



KK12b

Sidewinder Offset Conversion Kit

Z34 Ø18 SW Crowns + Z11 Ø 6.5mm Pinion



KK10b

Anglewinder Conversion Kit

Z30 AW Crowns + Z11 Ø 6.5mm Pinion

25



KK14c

Flat Anglewinder Offset Conversion Kit

Z25 Ø15 AW plastic Crown + Z11 Ø 6.5mm Pinion



KK16

Flat Anglewinder Offset PCR Conversion Kit

Z28 Ø15 AW plastic Crown + Z11 Ø 6.5mm Pinion



System



CH107
Z16 pulley
for magnesium
wheels



●
CH99
Z16 pulley
cyan - (2x)



● ●
CH100
Z17 pulley
black - (2x)



● ● ●
CH101
Z18 pulley
yellow - (2x)



26 PA72as
Assembled front plastic 4WD
Ø15.8 x 8.2 wheels (2x)

PA73as
Assembled front plastic 4WD
Ø16.5 x 8.2 wheels (2x)



PA72
Front plastic wheels
Ø15.8 mm (2x)

PA74as
Assembled front plastic 4WD
Ø17.3 x 8.2 wheels (2x)



PA73
Front plastic wheels
Ø16.5 mm (2x)

PA74
Front plastic wheels
Ø17.3 mm (2x)









CH95
Hubs for 4WD
front wheels (2x)



CH96
Bearings for 4WD
front wheels (2x)



System

- CH102 > Z85 
- CH108 > Z94 
- CH116 > Z96 
- CH113 > Z108 
- CH103 > Z110 
- CH104 > Z111 

Zxxx

Toothed belt for 4WD system

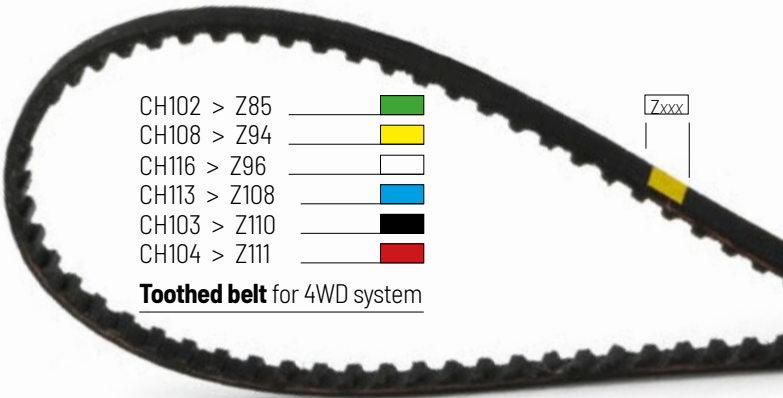

CH98
Tensioner, flanges and spacers

CH98y
Tensioner, flanges and spacers
yellow 

27

CH98c
Tensioner, flanges and spacers
cyan 



PA69
Ø 17.3 kit wheel
inserts for 4WD wheels



CH97
Snap rings
for 4WD front wheels (10x)

CH94
0.08mm spacers
for 4WD wheels (6x)



Motors

The **Slot.it** motors come in three different shapes: traditional **V12/4** type, longer '**Boxer**' type, or Slot.it's own '**Flat-6**'. 'Inline' means the motor axle is perpendicular to the rear axle.

'**Sidewinder**' means that the motor runs parallel to the rear axle, i.e. transversely.



INLINE



SIDEWINDER

28



ANGLEWINDER



INLINE BOXER

The **V12/4** motors features a double axle, which makes it a universal motor upgrade for cars of most makers.

Further, a special 'RX' adapter is available, to upgrade cars with such a 'RX' motor to a V12 one.

The '**Boxer**' type motors are an ideal upgrade for the bigger motors found on some slot cars. They can also be used as inline or 'anglewinder'.

Motors

The **FLAT-6** is a custom-built Slot.it motor designed both to be compatible with the existing Boxer/NC type motor pods, and to take advantage of a lower center of gravity when used in the special Slot.it motor pods, due to its 'slim' form, that also make it possible using it in anglewinder configuration under streamlined LMP racers like Slot.it's **Audi R8C**, **Lola LMP** and **Audi R18 TDI**.



Boxer motor mount



Flat motor mount

29

Our motors **MX16** and **MX16-m** will soon be produced with a white plastic endbell, instead of red. To differentiate them from **MX17**, that are already white, **RPM** will be engraved on the side of the metal case, for example **21K** or **23K**.



Motors Flat-6



The Flat-6 is a Slot.it proprietary design

MN09CH

Flat-6 GT/LMP

Slot.it models box stock
20.500 rpm - 200g*cm @12V



30



MN13CH

Flat-6S

22.500 rpm - 230g*cm @12V



GT RACING

MN14H

Flat-6RS

25.000 rpm - 240g*cm @12V - asymmetric case openings



MN11H-2

Flat-6R

22.000 rpm - 220g*cm @12V



High magnetic traction

Motors Boxer/ V12

The Boxer/2 is the most powerful Slot.it motor.



MN08CH
Boxer/2

21.500 rpm - 340g*cm @12V



MX15
V12/4 Classic DTM

Slot.it models box stock
21.000 rpm - 150g*cm @12V



MX16
V12/4 Gr.C/Classic

Slot.it models box stock
23.000 rpm - 170g*cm @12V

31



MX16-M
V12/4 Gr.C/Classic

Slot.it models box stock
23.000 rpm - 170g*cm @12V



MX17
V12/4

29.000 rpm - 160g*cm @12V



SP08

Adaptor V12 to RX shape motor

Pinions

∅ 5.5 mm - Brass



Pinion 8 teeth (2x) _____ PI08

Pinion 9 teeth (2x) _____ PI09

Pinion 10 teeth (2x) _____ PI10

Pinion 11 teeth (2x) _____ PI11

Pinion 8+9+10+11 teeth (4x) _____ PIMX

32

∅ 6 mm - Brass



Pinion 10 teeth (2x) _____ PI6010o

Pinion 11 teeth (2x) _____ PI6011o

∅ 6.75 mm - Brass



Pinion 11 teeth (2x) _____ PI6711o

Pinion 12 teeth (2x) _____ PI6712o

Pinions

Ø 6.5 mm - Brass



Pinion 10 teeth (2x) _____ PS10

Pinion 11 teeth (2x) _____ PS11

Pinion 12 teeth (2x) _____ PS12

Pinion 13 teeth (2x) _____ PS13

Pinion 10+11+12+13 teeth (4x) _____ PSMX

Ø 6.5 mm - Ergal

33



Pinion 10 teeth (1x) _____ PI6510e

Pinion 11 teeth (1x) _____ PI6511e

Pinion 12 teeth (1x) _____ PI6512e

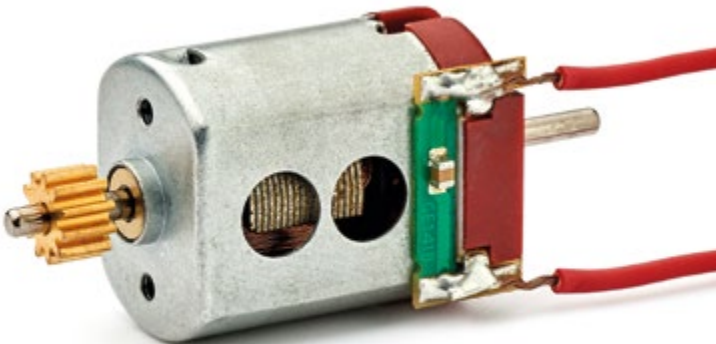

Pinions

Ø 7 mm - Ergal



Pinion 12 teeth (1x)	_____	PI7012e
Pinion 13 teeth (1x)	_____	PI7013e
Pinion 14 teeth (1x)	_____	PI7014e

Possibly the best pinion in the world:
0.3 grams only, chemically hardened and Teflon coated

34

Ø 5.5 mm - Internal Ø 1.5mm



Pinion 9 teeth (2x)	_____	PI559o15
Pinion 10 teeth (2x)	_____	PI5510o15

Ø 6 mm - Internal Ø 1.5mm



Pinion 10 teeth (2x)	_____	PI6010o15
-----------------------------	-------	-----------

Extractor / Press

The SLOT.IT extractor/press is made up of:

Main body **[1]** entirely made with anodized aluminium alloy designed to work with any slot electrical motor, from the most common short case to the more sophisticated, double long transmission shaft 4WD motors.

The main face was laser marked with a millimetre scale to easily control the insertion of the pinion.

Counter bushing **[6]** made of brass which, before using the tool, must be screwed onto the lower inside part of the main body.

The bushing has two very important functions:

- to centre the double shaft motor perfectly by means of the axle housing hole.

- to keep all those motors that are not equipped with the double shaft centred and, at the same time, safeguard the inner bush of those 'long can' motors motor that do not have an axle stub protruding from the can.

Special steel extraction plate **[5]** that fits in the relevant housing in the main body to extract the pinions. Besides being very resistant, this plate has a very thin eyelet located between the motor and the pinion: only 0.7 mm. This allows to extract also the pinions located very close to the motor case without causing any damage to it. Multifunction brass tool **[2]** which, depending on the operation to be performed, must be inserted in the main body with the plug (steel, interchangeable, $\varnothing 1.9$ mm in order not to damage the pinion hole) downwards, in case of the extractor, or the pinion housing downwards, in case of the press. The pinion housing for this element were designed to house pinions with a diameter ranging from 5.5mm to 7.5mm without damaging them.

The steel plug **[3]** is locked into the brass tool by means of an M3 grub screw **[4]**.

Advancement screw **[7]** on whose upper part there is an ergonomic plastic knob **[8]**, while the lower part is suitable to couple perfectly with the tool bevel, reduce friction and allow the press to operate perpendicularly without clearance.



35



TL01

Professional Extractor Press

Extractor / Press



36

PRESS THE PINION
LEAVING MOTOR
AND CROWN
IN PLACE

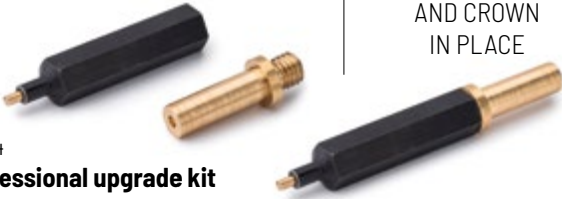

TL04

Professional upgrade kit
for extractor press TL01/SP21



TL02

Extraction plate and counter
plate spares for TL01/SP21



SP28

Multifunction brass tool steel
plug and M3 screw for SP21/TL01

Extractor/Press



SP38

Steel plug

ø 1.3 mm for extractor SP21/SP31b/TL01/TL05 (1x)



37



PULL THE PINION
LEAVING MOTOR
AND CROWN
IN PLACE

TL05

Professional Mini Puller

Sidewinder Spur Gears

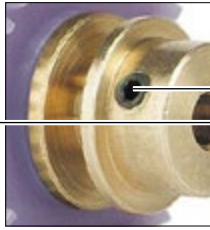
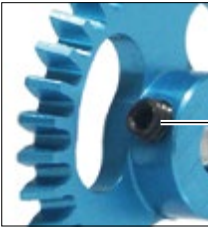

M2 HEX
SCREW



34 teeth Ergal light Ø19 mm

GS1934

36 teeth Ergal light Ø19 mm

GS1936

38 teeth Ergal light Ø19 mm

GS1938

38



31 teeth Ergal light Ø18 mm

GS1831

32 teeth Ergal light Ø18 mm

GS1832

32 teeth Aluminium + Plastic Ø18 mm

GS1832-pl

33 teeth Ergal light Ø18 mm

GS1833

34 teeth Ergal light Ø18 mm

GS1834

35 teeth Ergal light Ø18 mm

GS1835

36 teeth Ergal light Ø18 mm

GS1836

Inline Crown Gears



39

23 teeth Bronze/ Alumin. +Teflon	_____	GI23-bz / GI23-al
24 teeth Bronze/ Alumin. +Teflon	_____	GI24-bz / GI24-al
25 teeth Bronze/ Alumin. +Teflon	_____	GI25-bz / GI25-al
26 teeth Bronze/ Alumin. +Teflon	_____	GI26-bz / GI26-al
27 teeth Bronze/ Alumin. +Teflon	_____	GI27-bz / GI27-al
28 teeth Bronze/ Alumin. +Teflon	_____	GI28-bz / GI28-al
29 teeth Bronze/ Alumin. +Teflon	_____	GI29-bz / GI29-al
30 teeth Bronze/ Alumin. +Teflon	_____	GI30-bz / GI30-al

Set 24-26-27-28-30 teeth - Bronze insert

GI1

Inline Crown Gears

40



23 teeth	Bronze/ Alumin. +Teflon	_____	G023-bz / G023-al
24 teeth	Bronze/ Alumin. +Teflon	_____	G024-bz / G024-al
25 teeth	Bronze/ Alumin. +Teflon	_____	G025-bz / G025-al
26 teeth	Bronze/ Alumin. +Teflon	_____	G026-bz / G026-al
27 teeth	Bronze/ Alumin. +Teflon	_____	G027-bz / G027-al
28 teeth	Bronze/ Alumin. +Teflon	_____	G028-bz / G028-al
29 teeth	Bronze/ Alumin. +Teflon	_____	G029-bz / G029-al
30 teeth	Bronze/ Alumin. +Teflon	_____	G030-bz / G030-al

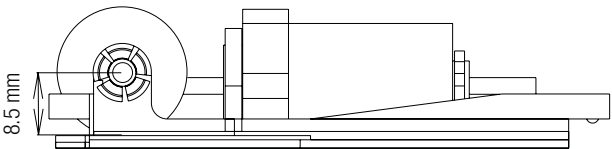

FOR OFFSET MOTOR MOUNT CH24B - CH49B



Modular crown



42

23 teeth modular crown, offset	_____	GM23o
24 teeth modular crown, offset	_____	GM24o
25 teeth modular crown, offset	_____	GM25o
26 teeth modular crown, offset	_____	GM26o
27 teeth modular crown, offset	_____	GM27o
28 teeth modular crown, offset	_____	GM28o
29 teeth modular crown, offset	_____	GM29o
30 teeth modular crown, offset	_____	GM30o



Ferrule for Ø5,5mm pinions	_____	GMF55
Ferrule for Ø6mm pinions	_____	GMF60

Modular crown



23 teeth modular crown, inline	_____	GM23i
24 teeth modular crown, inline	_____	GM24i
25 teeth modular crown, inline	_____	GM25i
26 teeth modular crown, inline	_____	GM26i
27 teeth modular crown, inline	_____	GM27i
28 teeth modular crown, inline	_____	GM28i
29 teeth modular crown, inline	_____	GM29i
30 teeth modular crown, inline	_____	GM30i

Anglewinder Gears

Ergal Anglewinder Gears



26 teeth	Ergal light Ø16 mm	_____	GA1626e
27 teeth	Ergal light Ø16 mm	_____	GA1627e
28 teeth	Ergal light Ø16 mm	_____	GA1628e
29 teeth	Ergal light Ø16 mm	_____	GA1629e
30 teeth	Ergal light Ø16 mm	_____	GA1630e
31 teeth	Ergal light Ø16 mm	_____	GA1631e

44



32 teeth	Ergal light Ø18 mm	_____	GA1832e
33 teeth	Ergal light Ø18 mm	_____	GA1833e
34 teeth	Ergal light Ø18 mm	_____	GA1834e
35 teeth	Ergal light Ø18 mm	_____	GA1835e
36 teeth	Ergal light Ø18 mm	_____	GA1836e

Anglewinder Gears

Ø15mm Plastic Anglewinder Gears

REQUIRES Ø 6.75 mm PINIONS



24 teeth for Flat Anglewinder Aluminium + Plastic _ GA1524-PI

25 teeth for Flat Anglewinder Aluminium + Plastic _ GA1525-PI

26 teeth for Flat Anglewinder Aluminium + Plastic _ GA1526-PI

Long Hub Anglewinder Gears

45

REQUIRES Ø 6.75 mm PINIONS



GA24LH

24 teeth - Ergal - Ø15 mm

All Gr.C and GT cars can be fitted with either a **Boxer** or a **Flat-6** in angled position ("anglewinder"). LMP models (**Lola, Audi R18, Audi R8C**), can only be fitted with an angled Flat-6.

A spacer, whose thickness should be adjusted according to the displacement of motor and wheels shafts, should be placed between motor mount and crown. Consider that Flat-6's shaft lies 1.25mm lower than Boxer's. As a rule of thumb, if the motor and wheel shafts are at the same height use 0 / 0.10mm spacer, increasing to 0.40mm all the way to 1.0 mm offset chassis with **Flat-6** motor (in which case the displacement of shafts is 2.25mm): roughly, 0.17mm spacer every 1mm displacement.

Anglewinder Gears

Ø16 mm Plastic Anglewinder Gears



26 teeth Aluminium + Plastic	_____	GA1626-PI
27 teeth Aluminium + Plastic	_____	GA1627-PI
28 teeth Aluminium + Plastic	_____	GA1628-PI
29 teeth Aluminium + Plastic	_____	GA1629-PI
30 teeth Aluminium + Plastic	_____	GA1630-PI



AVAILABLE GEAR RATIOS

Pinions			Inline crowns										Sidewinder Ø18mm spur gears						Sidewinder Ø19mm spur gears			Anglewinder Ø15mm gears			Anglewinder Ø16mm gears						Anglewinder long hub gears					
Ø5.5 mm	Ø6.5 mm	Ø7 mm	23	24	25	26	27	28	29	30	31	32	33	34	35	36	34	36	38	24	25	26	26	27	28	29	30	31	32	33	34	35	36	24	26	
8			2.88	3.00	3.13	3.25	3.38	3.50	3.63	3.75							4.25	4.50	4.75																	
9			2.56	2.67	2.78	2.89	3.00	3.11	3.22	3.33							3.78	4.00	4.22																	
10	10		2.30	2.40	2.50	2.60	2.70	2.80	2.90	3.00	3.10	3.20	3.30	3.40	3.50	3.60	3.40	3.60	3.80					2.60	2.70	2.80	2.90	3.00	3.10	3.20	3.30	3.40	3.50	3.60		
11	11	11	2.09	2.18	2.27	2.36	2.45	2.55	2.64	2.73	2.82	2.91	3.00	3.09	3.18	3.27	3.09	3.27	3.45					2.36	2.45	2.55	2.64	2.73	2.82	2.91	3.00	3.09	3.18	3.27	2.18	2.36
	12	12									2.58	2.67	2.75	2.83	2.92	3.00	2.83	3.00	3.17	2.00	2.08	2.17	2.17	2.25	2.33	2.42	2.50	2.58	2.67	2.75	2.83	2.92	3.00	2.00	2.17	
	13	13									2.38	2.46	2.54	2.62	2.69	2.77	2.62	2.77	2.92	1.85	1.92	2.00	2.00	2.08	2.15	2.23	2.31	2.38	2.46	2.54	2.62	2.69	2.77			
		14																		1.71	1.79	1.86														

Inline crown
Offset crown
18mm spur gear
19mm spur gear

GI23/24/25/26/27/28/29/30 require CH13c/CH70/CH48/CH48b motor mount and brass 5.5mm pinions P108/09/10/11
 G023/24/25/26/27/28/29/30 require CH24b/CH48b offset motor mounts and brass 5.5mm pinions P108/09/10/11
 GS1831/32/33/34/35/36 require CH67/CH68/CH69 motor mounts and brass 6.5mm pinions PS10/11/12/13 or Ergal 6.5mm pinions P16510E/6511E/6512E/6513E
 GS1934/36/38 require CH65/CH67/CH68/CH69 motor mount and 6mm pinions P160110/60120.

Anglewinder Ø16 gears

GA34/36 and GA1626E/1627E/1628E/1629E/1630E/1631E/1632E/1633E/1634E/1635E require CH61/60b/74/75/76/82 motor mounts and brass 6.5mm pinions PS10/11/12/13 or Ergal 6.5mm pinions P16510E/6511E/6512E/6513E.
 GA1626-P1/1627-P1/1628-P1/1629-P1/1630-P1 require brass 6mm pinions P160110/60120 and 0.75mm spacer PA52. Otherwise require brass 6.5mm pinions PS10/11/12/13 or Ergal 6.5mm pinions P16510E/6511E/6512E/6513E.

Anglewinder long hub gears
Anglewinder Ø15 gears
Anglewinder Ø15 gears

GA24LH/26LH require CH61/60b/74/75/76/82 motor mounts and brass 6.75mm pinions P67110/67120.
 GA1524-P1/1525-P1/1526-P1 require brass 6.5mm pinions PS10/11/12/13 and 1mm spacer PA51 or Ergal 6.5mm pinions P16510E/6511E/6512E/6513E and 1mm spacer PA51.
 GA1524-P1/1525-P1/1526-P1 require Ergal 7mm pinions P17012E/7013E/7014E without spacers

Starter Kit

KK01b

Kit inline

Z28 crown

15.8x8.2x1.5mm wheels



KK07c

Kit inline

Z28 crown

17.3x9.75x1.5mm wheels

+ 1mm spacers



KK08b

Kit inline

Z27 crown

15.8x8.2x2.5mm plastic wheels



KK06c

Kit inline

Z24 crown + Z10 pinion

14.4x11.5x1.5mm wheels (F1 type)



KK03c

Kit inline

Z26 crown + Z9 pinion

17.3x9.75x1.5mm wheels

+ 1mm spacers



KK17

Kit inline

Z26 crown

17.3x9.75mm wheels



Starter Kit

KK02b

Kit sidewinder

Z36 Ø19 crown

15.8x8.2x1.5mm wheels

+ 1mm spacers



KK04c

Kit sidewinder

Z36 Ø19 crown

17.3x9.75x1.5mm wheels

+ 1mm spacers



KK05b

Kit sidewinder

Z34 Ø18 crown

15.8x8.2x1.5mm wheels

+ 1mm spacers



KK15b

Kit sidewinder

Z36 Ø19 crown

17.3x8.2x1.5mm wheels

+ 1mm spacers



KK09d

Kit anglewinder

Z32 crown + Z12 pinion

17.3x9.75x1.5mm wheels



49



Wheels

∅ 14.3 x 8 mm



W14308015A ex PA33-Als
Al ∅14.3 x 8 x 1.5mm
wheels, M2 grub - 1.2g (2x)



W14308015P ex WH1215-PI
PI ∅14.3 x 8 x 1.5mm
wheels, M2 grub - 0.59g (4x)

∅ 14.4 x 11.5 mm

W14411515A ex PA20-Als
Al ∅14.4 x 11.5 x 1.5mm
F1 wheels, M2 grub - 1.5g (2x)



50

∅ 15.8 x 8.2 mm



W15808225A ex WH1050-Al
Al ∅15.8 x 8.2 x 2.5mm
wheels, M2 grub - 1.4g (2x)



W15808225M ex PA17-Mg
Mg ∅15.8x8.2x2.5mm
wheels, M2 grub - 0.9g (2x)



W15808215A ex PA24-Als
Al ∅15.8 x 8.2 x 1.5mm
wheels,
M2 grub - 1.4g (2x)



W15808215M ex WH1183-Mg
Mg ∅15.8 x 8.2 x 1.5mm
hollow wheels,
M2 grub, 0.8g (2x)

Wheels

∅ 15.8 x 8.2 mm



W15808215AF *ex PA24-Alf*
Al ∅15.8 x 8.2 x 1.5mm
wheels double shoulder
M2 grub - 1.1g (2x)



W15808215AH *ex PA24-Alh*
Al ∅15.8 x 8.2 x 1.5mm
wheels double shoulder
holed channel M2 grub - 1g (2x)



W15808215P *ex WH1210-PI*
PI ∅15.8x8.2x1.5mm
wheels 0.7g (4x)



W15808225P *ex PA17-PI*
PI ∅15.8x8.2x2.5mm
wheels 0.71g (4x)

51

∅ 15.8 x 10.2 mm



W15810215AF *ex PA49-Alf*
Al ∅15.8 x 10.2 x 1.5mm
wheels, double shoulder,
M2 grub - 1.3g (2x)



W15810215AH *ex PA49-Alh*
Al ∅15.8 x 10.2 x 1.5mm
wheels, double shoulder
holed channel, M2 grub - 1.2g (2x)

W15810215M *ex WH1184-Mg*
Mg ∅15.8 x 10.2 x 1.5mm
hollow wheels, M2 grub, 0.9g (2x)



Wheels

∅ 16.5 x 8.2 mm

W16508215A ex PA43-Als
Al ∅16.5 x 8.2 x 1.5mm
wheels, M2 grub, 1.5g (2x)



W16508215M ex WH1185-Mg
Mg ∅16.5 x 8.2 x 1.5mm
hollow wheels, M2 grub, 0.75g (2x)



W16508225P ex PA43-PI
PI ∅16.5 x 8.2 x 2.5mm
wheels, 0.76g - (4x)



∅ 16.5 x 10.2 mm

W16510215M ex WH1186-Mg
Mg ∅16.5 x 10.2 x 1.5mm
hollow wheels, M2 grub, 0.9g (2x)



∅ 16.9 x 8.2 mm

W16908215M ex WH1288-Mg
Mg ∅16.9 x 8.2 x 1.5mm
hollow wheels, M2 grub, 0.78g (2x)



∅ 17.3 x 8.2 mm

W17308225A ex WH1048-Al
Al ∅17.3 x 8.2 x 2.5mm
wheels, M2 grub, 1.6g (2x)



Wheels

Ø 17.3 x 8.2 mm

W17308215A ex WH1110-Al
Al Ø17.3 x 8.2 x 1.5mm
wheels, M2 grub, 1.6g (2x)



W17308215M ex WH1230-Mg
Mg Ø17.3 x 8.2 x 1.5mm
hollow wheels, M2 grub, 0.8g (2x)



W17308205P ex WH1254-PI
PI Ø17.3 x 8.2 x 0.5mm
wheels, 0.75g (4x)



W17308215P
PI Ø17.3 x 8.2 x 1.5mm
wheels, 0.72g (4x)



W17308225P ex WH1071-PI
PI Ø17.3 x 8.2 x 2.5mm
wheels, 0.8g (4x)



Ø 17.3 x 9.75 mm

W17309715A ex PA62-Als
Al Ø17.3 x 9.75 x 1.5mm
wheels, M2 grub, 1.6g (2x)



W17309715M ex WH1231-Al
Mg Ø17.3x9.75x1.5mm
hollow wheels, M2 grub, 0.9g (2x)



Wheels

Ø 17.3 x 10 mm

W17310005P *ex WH1179-PI*

PI Ø17.3 x 10 x 0.5mm

wheels, 0.85g (4x)



For Sponge Tyres

Compatible with Slot.it wheel inserts

W13609515A *ex WH1211-AI*

Ø13.6 x 9.5 x 1.5mm

wheels equivalent Ø15.8mm

M2 grub (2x)



W14209515A *ex WH1190-AI*

Ø14.2 x 9.5 x 1.5mm

wheels equivalent Ø16.5mm

M2 grub (2x)



W15009515A *ex WH1212-AI*

Ø15.0 x 9.5 x 1.5mm

wheels equivalent Ø17.3mm

M2 grub (2x)



PT1209SP30

SP30 compound

Sponge tyres

dwg 1209 (4x)



Axle and Spacer

PA01-45
PA01-48
PA01-51
PA01-54



Steel ProAxle turned ground, polished - 2.38 mm (3/32") (2x)

PA01-51H
PA01-54H



Steel ProAxle turned ground, polished, hollow - 2.38 mm (3/32") (2x)

PA01-48R
PA01-51R
PA01-54R

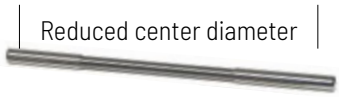

Steel ProAxle polished - 2.38 mm (3/32") for sidewinder (2x)

PA39
Independent front wheels axle



55

PA57



Light Stopper for anglewinder setup Aluminium (2x)

PA25



Stopper for anglewinder setup Aluminium+teflon (1x)

PA51

Set of spacers
for hubs 1mm thick (x10)



PA52

Set of spacers
for hubs and bushings
0.6mm thick



PA47

Set of spacers
for hubs and bushings
0.1 / 0.25mm thick

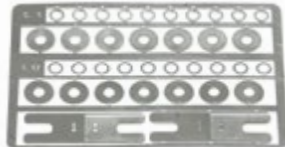

Plastic inserts

Classic '80s - Group C

(for Ø15.8mm and for Ø16.5mm wheels)

PA55

Plastic inserts BBS '80s

for Ø15.8mm (4x) Ø16.5mm (2x) wheels - Porsche 956/962 type



PA53

Plastic inserts

for Ø15.8mm (4x) Ø16.5mm (2x) wheels Lancia LC2-85 type



PA48

Plastic inserts

for Ø15.8mm (4x) Ø16.5mm (2x) wheels Toyota 88C type



PA65

Plastic inserts

for Ø15.8mm (2x) Ø16.5mm (2x) wheels Nissan R89C type



PA44

Plastic inserts

for Ø15.8mm wheels (4x) - Mazda 787B type



PA30

Plastic inserts

for Ø15.8mm wheels (4x) - Sauber C9 type



Plastic inserts

Classic '80s - Group C

(for Ø15.8mm and for Ø16.5mm wheels)



PA31

Plastic inserts

for Ø15.8mm wheels (4x) - Jaguar XJR type



PA34

Plastic inserts

for Ø15.8mm wheels (4x) - Lancia LC2-84 type



Plastic inserts

Modern GT/LMP

(for Ø15.8mm wheels)



- **black** Plastic inserts BBS for Ø15.8mm wheels _____ PA03b
 - **silver** Plastic inserts BBS for Ø15.8mm wheels _____ PA03s
 - **gold** Plastic inserts BBS for Ø15.8mm wheels _____ PA03g
-

Modern GT/LMP

(for Ø17.3mm wheels)

58



PA60

Plastic inserts BBS

for Ø17.3mm wheels (4x)

Porsche 911 GT1 - Lola B09 B10 B11 - Aston Martin type



PA79

Plastic inserts OZ

for Ø17.3mm wheels (4x) - Maserati GT3



PA36

Plastic inserts OZ

for Ø17.3mm wheels (4x)

McLaren F1 GTR type

Plastic inserts

Classic '70s

(for Ø14.3mm and for Ø15.8mm wheels)

PA63

Plastic inserts

for Ø15.8mm wheels (4x) - McLaren M8D type



PA64

Plastic inserts

for Ø15.8mm wheels (4x)
Matra-Simca MS670B type



PA41

Plastic inserts

for Ø15.8mm (4x) Ø14.3mm (2x)
wheels Alfa Romeo 33/3 type



PA45

Plastic inserts

for Ø15.8mm wheels (4x)
Chaparral 2E type



PA46

Plastic inserts

for Ø15.8mm wheels - (4+4)
Ford GT40 type



Plastic inserts

F1 (for Ø14.4mm wheels)



- **black** Pl. ins. BBS for Ø14.4mm wheels (4x) F1 type — PA13b
 - **silver** Pl. ins. BBS for Ø14.4mm wheels (4x) F1 type — PA13s
 - **gold** Pl. ins. BBS for Ø14.4mm wheels (4x) F1 type — PA13g
-

Classic DTM (for Ø15.8mm wheels)

60



PA71

Plastic inserts Speedline
for Ø15.8mm wheels (4+2)



PA75

Plastic inserts OZ
for Ø15.8mm wheels (4+2)



PA77

Plastic inserts BBS type
for Ø15.8mm wheels (4+2)

Classic DTM (for Ø15.8mm wheels)



PA78

Plastic inserts OZ

for Ø15.8mm wheels (4+2)



Tyres



Low profile front tyre



High grip rear tyre



Realistic thread rear tyre



F1 rear tyre

PT19 > **Z1** - 8x14.2 (4x)
dwg 1096 - Low profile slick

PT1214S2 > **S2** - 8.4x14.6 (4x)
dwg 1214 - Low profile slick

PT1088C1 > **C1**
dwg 1088 - slick 8x16.1 (4x)

PT1159C1 > **C1**
dwg 1159 - slick 9.5x17.2 (4x)

PT1228C1 > **C1**
dwg 1228 - slick 9.5x17.8 (4x)

PT35 > **C1**
dwg 1140 - slick 9.5x19.8 (4x)

PT15 > **Z0** - 10x16.5 (4x)
dwg 1067 - Low profile slick

PT1170E1 > **E1**
dwg 1170 - slick 10x17 (4x)

PT1167C1 > **C1** PT1167S2 > **S2**
dwg 1167 - slick 10x17.8 (4x)

PT1207N18 > **N18** PT1207P6 > **P6**
PT1207F22 > **F22**
dwg 1207 - slick 10x18 (4x)

DIMENSION OF TYRE AFTER ASSEMBLY ON WHEEL

REFERENCE BY TRACK - COMPOUND - TYRES CODE

Suggested use >	Ninco		Carrera	Front wheels only			Any			
	P5	E1	P6	Z0	Z1	S2	F15	F22	F30	N18
Compound >	PT23	PT1170E1	PT24 PT25 PT1207P6	PT07 PT15	PT19	PT1214S2	PT26	PT27 PT29 PT1207F22	PT28	PT1207N18
Reference Code >										

■ = box stock

REFERENCE BY WHEELS DIMENSION - TYRES CODE/DWG

WHEELS dim.(mm)	PT19	PT1214S2	PT1088C1	PT1159C1	PT1228C1	PT35	PT15	PT1170E1	PT1167C1 PT1167S2
	14.3 x 8	15.1	15.1	17	x	x	x	x	17.1
14.4 x 11.5	x	x	x	x	x	x	x	x	x
15.8 x 8.2 15.8 x 10.2	16.7	16.7	18.4	18.3	19.8	20.1	17	18.5	19.1
16.5 x 8.2 16.5 x 10.2	17.3	17.3	19	18.9	20.3	20.6	17.6	19.1	19.6
16.9 x 8.2	17.6	17.6	19.3	19.2	20.6	20.9	17.9	19.4	19.9
17.3 x 8.2 17.3 x 9.75 17.3 x 10	18.1	18.1	19.7	19.4	21	21.3	18.3	19.8	20.3
dwg	1096	1214	1088	1159	1228	1140	1067	1170	1167
Tyres dimension (mm)	8 x 14.2	8.4 x 14.6	8 x 16.1	9.5 x 17.2	9.5 x 17.8	9.5 x 19.8	10 x 16.5	10 x 17	10 x 17.8

Slot.it provides a comprehensive range of tires for the racer and the scale modeler alike.



Sponge tyre

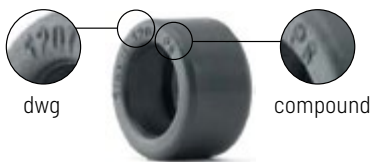

dwg

compound

PT34 > **C1**

dwg 1045 - slick 10x18.5 (4x)

PT06 > **S1** PT07 > **Z0**

PT24 > **P6**

dwg 1027 - slick 10x18.8 (4x)

PT26 > **F15** PT28 > **F30**

PT27 > **F22** PT1171N22 > **N22**

dwg 1171 - slick 10x19.5 (4x)

PT2120C1 > **C1**

dwg 1121 - slick 10x19.5 (2x)

dwg 1120 - slick 10.5x20 (2x)

PT1152C1 > **C1**

dwg 1152 - slick 10.5x19 (4x)

PT18 > **S2**

dwg 1046 - slick 10.5x19.9 (4x)

PT1172N22 > **N22**

dwg 1172 - slick 11.3x20 (4x)

PT25 > **P6** PT03 > **S1**

dwg 1028 - 12.2x19.8 - (4x)

PT13 > **P3** PT16 > **S1**

PT23 > **P5** PT29 > **F22**

dwg 1068 - F1 12.4x20.4 - (4x)

		Scalextric Sport	Smooth and clean surface	
N22	SP30	C1	S1	S2
PT1171N22 PT1172N22	PT1209SP30	PT34 PT35 PT2120C1 PT1152C1 PT1159C1 PT1167C1 PT1088C1 PT1228C2	PT03 PT06 PT16	PT17 PT18 PT1167S2

SPONGE TYRES

Compound	SP30
Code	PT1209 SP30
dwg	1209
Tyres dimension (mm)	9.5 x 19.5

WHEELS FOR SPONGE TIRES (9.5 mm)

Code	Diameter	Equivalence
W13609515A	13.0	15.8
W14209515A	14.2	16.5
W15009515A	15.0	17.0

PT1207N18 PT1207F22 PT1207P6	PT34	PT06 PT07 PT24	PT26 PT27 PT28 PT1171N22	PT2120C1	PT1152C1	PT18	PT17	PT2120C1	PT1172N22	PT25 PT03	PT13 PT16 PT23 PT29
x	x	x	x	x	x	x	x	x	x	x	x
x	x	x	x	x	x	x	x	x	x	x	20.8
19.6	18.8	19	19.7	19.4	19	x	19.7	19.9	19.9	19.7	x
20.2	19.4	19.6	20.3	20	19.6	x	20.2	20.5	20.4	20.3	x
20.5	19.7	19.9	20.6	20.3	19.9	x	20.5	20.8	20.7	20.6	x
20.8	20.1	20.2	21	20.7	20.3	20.2	20.8	21.2	21.1	21	x
1207	1045	1027	1171	1121	1152	1046	1042	1120	1172	1028	1068
10 x 18	10 x 18.5	10 x 18.8	10 x 19.5	10 x 19.5	10.5 x 19	10.5 x 19.9	10.5 x 20	10.5 x 20	11.3 x 20	12.2 x 19.8	12.4 x 20.4

Bushings & Pulleys



CH105
Flanged bearings for
 CH118 - CH119 - CH115 - CH117
 and for Policar F1 (2x)



CH14
Bronze spherical bushings (2x)

PA02
Bronze bushings (2x)



PA32
Aluminium bushings
 Aluminium+Teflon (2x)



PA12
Brass bushings
 old Carrera (2x)



PA11
Bronze bushings
 for Proslot (2x)



PA68
Brass bushings
 for Carrera and Scalextric (4x)



PA27
Bronze bushings
 Double side (4x)



CH56b
Bronze spherical bushings
 Standard Slot.it models (6x)



PA28
Aluminium pulley (2x)



PA26
Plastic CNC machined pulley (2x)



Suspensions



CH47b
Spring suspension kit - for all type of motor mounts



Springs For CH47B Suspension

CH55A
Soft springs (8x)



CH55B
Medium springs (8x)



CH55C
Ultra soft springs (8x)



Suspensions

CH55D

Short ultra soft springs (8x)



CH77

Aluminium anodized end of run nuts (4x)

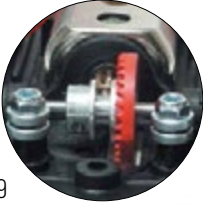

CH09

Magnetic suspension kit

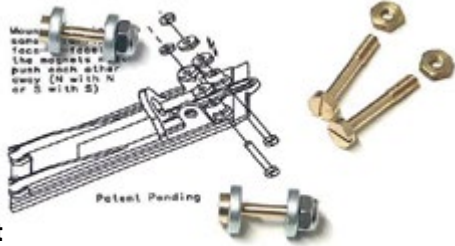

CN08 - Ø 4x1mm (8x)

CN09 - Ø 4x1.5mm (8x)

CN10 - Ø 6x1.4mm (8x)

Neodymium magnet for magnetic suspension kit



Magnets & Ballast

CN01

Neodymium magnet

25x8x2mm for Scalextric



CN02

Neodymium C shaped magnet

25x8x2.3mm for Scalextric



CN06

Neodymium standard magnet

for motor mounts



CN07

Neodymium race magnet

for motor mounts



CN11b - **Neodymium magnet**

25x8x4mm magnet (oXigen) - 2x



SP23

Tungsten ballast

motor mount
shape 2.5g (1x)



SP25

Tungsten ballast putty

10g (1x)



SP24 - **Tungsten ballast cylinder**

6.3x1mm, 0.58g (6x)



Screwdrivers



PA76

Adjustable torque hex
M2 screwdriver



PA67c

Adjustable torque Torx
T3 screwdriver



PA67b

Adjustable torque hex
M2.5 screwdriver



PA06

Hexagonal wrench
M2

Screws

66

PA58

Hexagonal screws
M2 x 2mm (10x)



PA40

Hexagonal screws
M2 x 3mm (10x)



PA37

Hexagonal screws
for front axle setup
M2 x 6mm (10x)



PA50

Hexagonal screws
M2 x 8mm (10x)



PA54

Hexagonal screws
M2 x 10mm (10x)



PA66

Torx screws
T3 x 3mm (10x)



CH54b

Metric screws
chamfered large head
2.2 x 5.3 mm (10x)



CH59

Metric screws
chamfered large head
for suspensions
L9mm + L13mm (2+2)



CH89

Metric screws
brass M2.5x6mm
for Carrera (10x)



CH41b

**Replacement
motor
fixing metric screws** (10x)



Screws



CH51

Metric screws 2.2 x 8mm
small head (10x). Use for body
or in conjunction with CH72



CH52

Metric screws
2.2x8mm big head (10x)



CH53

Metric screws
2.2x5.3mm small head (10x)



CH54

Metric screws
2.2x5.3mm big head (10x)



CH28

Set of screws
for cars (8 short - 4 long)



CH106

Set of screws
for motor mount (8x)



CH39

Set of screws
for HRS2 chassis



CH08

Set of screws
for HRS chassis

CH90

Motor fixing screws
M2 x 4 mm titanium (4x)



Cars spare parts

	MODEL	CODE	CHASSIS	CRASHPROOF
CLASSIC DTM	Alfa Romeo 155 V6 TI (1993/94)	CA35	CS35t-60	CS35p
	Alfa Romeo 155 V6 TI (1995)	CA40	CS40t-60	CS35p / CS40p
	Alfa Romeo 155 V6 TI (1994/95)	CA50	CS50t-60	CS35p / CS40p
	Alfa Romeo 155 V6 TI (1996)	CA45	CS45t-60	CS35p / CS40p
	Mercedes 190E	CA44	CS44t	CS44p
	Opel Calibra V6	CA36	CS36t-60	CS36p
GROUP C	Jaguar XJR12	CA13	CS13t-60	CS07p
	Jaguar XJR6/9	CA07	CS13t-60	CS07p
	Lancia LC2-84	CA08	CS08t-60b	CS08p
	Lancia LC2-85	CA21	CS08t-60b	CS21p
	Mazda 787B	CA15	CS15t-60	CS15p
	Nissan R89C	CA28	CS28t-60	CS28p
	Porsche 956C KH	CA09	CS02t-60b*	CS02p/2
	Porsche 956C LH	CA02	CS02t-60b	CS02p/2
	Porsche 962 IMSA	CA25	CS03t-60c	CS02p/2
	Porsche 962C 85	CA34	CS03t-60c	CS02p/2
	Porsche 962C KH	CA17	CS03t-60c	CS02p/2
	Porsche 962C LH	CA03	CS03t-60c	CS02p/2
	Sauber C9	CA06	CS05t-60b	CS05p/2
	Toyota 88C	CA19	CS19t-60b	CS19p
Toyota 86C	CA41	CS19t-60b	CS41p	
CLASSIC	Alfa Romeo T33/3	CA11	CS11t-60b	CS11p
	Chaparral 2E	CA16	CS16t-60	CS16p/2 / CH71 / CH71lx
	Ford GT40	CA18	CS18t-60b	CS18p
	Ford MKII	CA20	CS18t-60b	CS18p
	Matra MS 670 B (1973)	CA37	CS27t-60	
	Matra MS 670 B (1974)	CA27	CS27t-60	CS27p
	McLaren M8D	CA26	CS26t-60	CS26p
GT	McLaren F1 GTR	CA10	CS10t-60b	CS10p
	Nissan R390 GT1	CA04/05	CS14t-60	CS04p
	Nissan R390 GT1 Long Tail	CA14	CS14t-60	CS04p
	Porsche 911 GT1 EV098	CA23	CS23t-60	CS23p
LMP	Audi R18 e-tron quattro	CA29	CS24t-60c	CS29p
	Audi R18 TDI	CA24	CS24t-60c	CS24p
	Audi R18 Ultra	CA38	CS24t-60c	CS38p
	Audi R8 LMP 2000	CA33	CS33t-60	CS33p
	Audi R8C	CA01	CS01t-2	CS01p
	Audi R8C Reloaded	CA12	CS12t-60	CS12p
	Lola Aston Martin DBR1-2	CA31	CS31t-60	CS31p
	Lola B09/60, B10/60, B11/80, B12/69 EV	CA22	CS22t-60c	CS22p
	Lola B12/80	CA39	CS22t-60c	CS22p
GT3	Maserati GT3	CA43	CS43t	CS43p

* from CA09e onwards

TRANSPARENT	COCKPIT		WHITE KIT	BODY KIT	
	POLYCARBONATE	PLASTIC			
CS35v / CS35vlx	CS35lx		CA35z	CS35b	
CS35v / CS35vlx			CA40z	CS50b	
CS35v / CS35vlx				CS50b	
CS35v / CS35vlx			CA45z		
CS44v	CS44x		CA44z	CS44b	
CS36v	CS36lx		CA36z	CS36b	
CS07v	CS07il	CH87		CS13b	69
CS07v	CS07il	CH87		CS07b	
CS08v	CS08il		CA08z	CS08b	
CS21v	CS08il		CA21za	CS21b	
CS15v	CS15lx			CS15b	
CS28v	CS28lx		CA28z	CS28b / CS28b1	
CS02v	CS02lx	CH81b		CS09b1	
CS02v	CS02lx	CH81b	CA02za	CS02b1	
CS02v	CS02lx	CH81b		CS25b	
CS02v	CS02lx	CH81b	CA34z	CS34b	
CS02v	CS02lx	CH81b		CS17b1	
CS02v	CS02lx	CH81b		CS03b1	
CS05v	CS05il	CH80		CS05b1	
CS19v	CS19il	CH92	CA19z	CS19b	
CS19v	CS19il	CH92		CS41b	
CS11v		CH58		CS11b1	
CS16v		CH78		CS16b1	
CS18v	CS18il			CS18b	
CS18v	CS18il			CS20b	
			CA37z	CS37b	
CS27v			CA27z	CS27b	
CS26v			CA26z	CS26b	
CS10v	CS10il	CH86		CS10b1	
CS04v	CS04lx		CA14z	CS14b	
CS04v	CS04lx		CA14z	CS14b	
CS23v	CS23lx			CS23b	
CS29v	CS24lx	CH91		CS29b	
CS24v	CS24lx	CH91		CS24b1/ CS24b2	
CS29v	CS24lx	CH91		CS38b	
CS33v			CA33z	CS33b	
	CS12il				
CS12v	CS12il			CS12b	
CS31v	CS22lx	CH93	CA31z1 / CA31z2	CS31b1 / CS31b2	
CS22v	CS22lx	CH93		CS22b1 / CS22b2	
CS39v/CS22v	CS22lx	CH93	CA39z	CS39b1 / CS39b2 / CS39la	
CS43v	CS43x		CA43z	CS43b	

Tune up your model with Slot.it parts and motor mounts!

Slot.it 3D printed chassis and parts are designed to fit under existing models made by other manufacturers.

By replacing the original chassis with a Slot.it 3D printed one, your slot car performance moves to the next level.

These chassis allow easy installation of Slot.it motor mounts hence of the complete Slot.it product line can be used as well.



We've also worked so that each chassis, whenever possible, is easily compatible with Scalextric SSD, oXigen, or Carrera D132. To this purpose there may be two different chassis available for each supported model: one for SSD, one for analog and oXigen digital or Carrera D132 digital chip installation.

70



Audi A5 - ssd



Audi A5 - std

Additional parts may be necessary to complete your assembly: SSD lid, D132 chip support, or special cockpits.



Search the Slot.it FAQ for lists of necessary parts for each supported model.



Speciality Slot Car racing parts On Demand

www.shapeways.com/shops/slotit



The Slot.it 3D Print Shop

By Maurizio Ferrari

3D prints of special parts created from Slot.it, the reference brand in slot car racing

MODEL	BRAND	MODEL	BRAND
Audi Sport Quattro S1 Gr.B	Scalextric	Audi S5 DTM	Carrera
Lancia Delta S4 Gr.B	Scalextric	BMW M3 DTM	Carrera
Bentley Continental GT3	Scalextric	Mercedes C-Klasse DTM	Carrera
Aston Martin Vantage GT3	Scalextric	Ferrari 458 GT3	Carrera
McLaren MP12-4C GT-3	Scalextric	BMW M4 DTM	Carrera

Vacuum forming cockpits 71



POLYCARBONATE COCKPITS			
S01-XA1	Polycarbonate cockpits for	Carrera	Audi A5 DTM
S02-XA1	Polycarbonate cockpits for	Carrera	BMW M3/M4 DTM
S03-XA1	Polycarbonate cockpits for	Carrera	Mercedes C-Klasse DTM
S04-XA1	Polycarbonate cockpits for	Scalextric	Audi Sport S1 Quattro
S05-XA1	Polycarbonate cockpits for	Scalextric	Lancia Delta S4
S06-XA1	Polycarbonate cockpits for	Scalextric	Bentley Continental GT3
S07-XA1	Polycarbonate cockpits for	Scalextric	Aston Martin Vantage GT3
S08-XA1	Polycarbonate cockpits for	Carrera	Ferrari 458
S09-XA1	Polycarbonate cockpits for	Scalextric	McLaren MP4-12C
S11-XA1	Polycarbonate cockpits for	Scalextric	BMW Z4 GT3
S18-XA1	Polycarbonate cockpits for	Scalextric	Porsche 911 RSR
S22-XA1	Polycarbonate cockpits for	Scalextric	Audi R8 LMS GT3
S23-XA1	Polycarbonate cockpits for	Scalextric	Mercedes AMG GT3
S24-XA1	Polycarbonate cockpits for	Policar	Toyota GT86

Electronic Controller SCP-3



Adjustable Brake
(Analog SSD digital)

Thumb Activated
Brake

Minimum Speed
Tuning

Quick action
curve selection

Antispin
Control

72

Lane Change (Digital) Brake override (Analogic)

SCP301a

SCP3 electronic controller analog

with Common Ground High Current Cartridge - For all slot cars

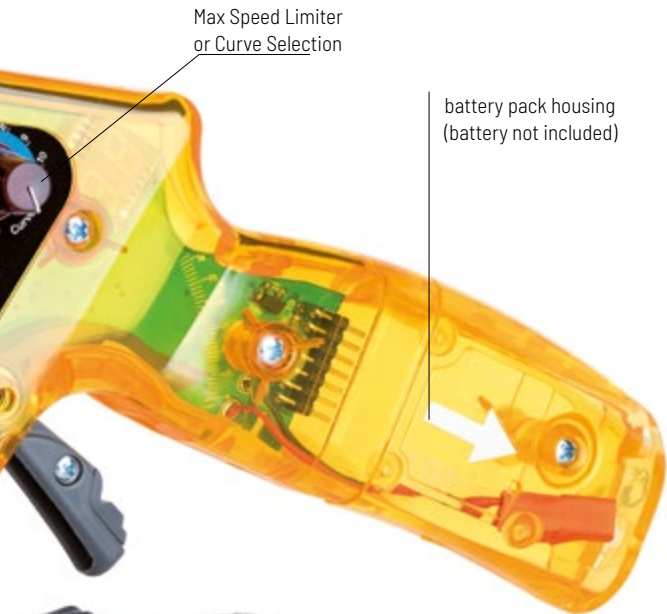

Max Speed Limiter
or Curve Selection

battery pack housing
(battery not included)

73

- 1 or 2 fingers lever
- Rubber injected finger touch
- Ball bearing spindle
- Contactless magnetic trigger system
- Optional battery wireless operation
(requires oXigen cartridge and CRI receiver)
- oXigen compatible (with oXigen cartridge)

Electronic Controller SCP-2

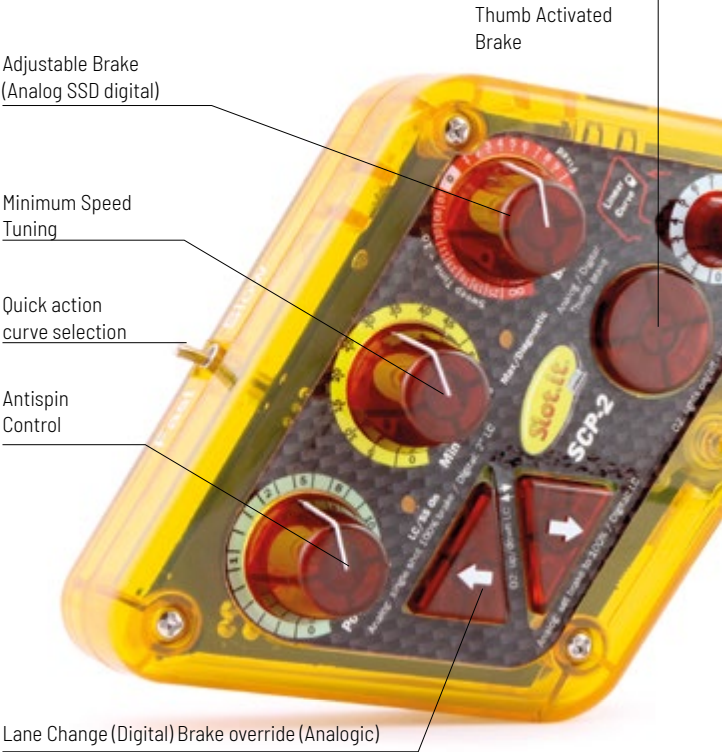

SCP201g

SCP2 analog common ground

(positive wiring) high current cartridge 20a cont. - 40A peak

Telemetry Data Interface (*)
Ghost Car Motor Test Mode

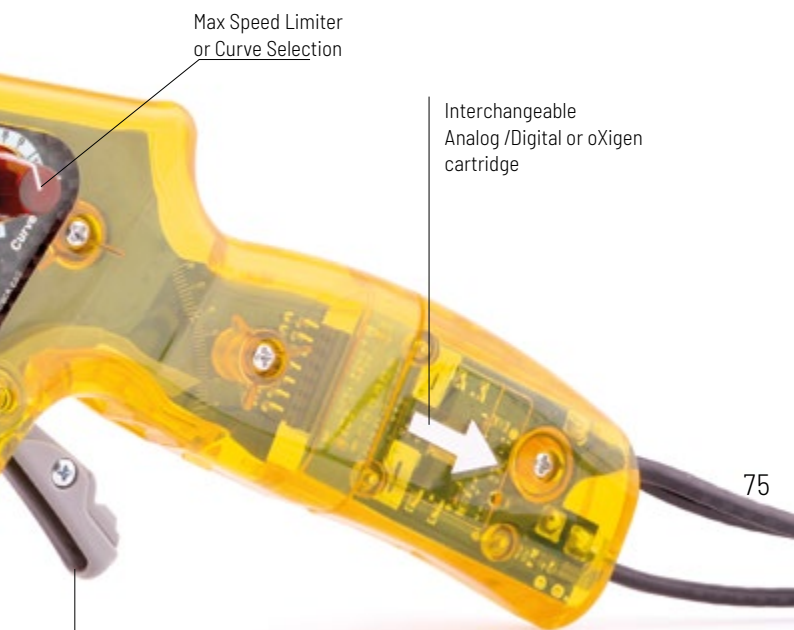

Max Speed Limiter
or Curve Selection

Interchangeable
Analog /Digital or oXigen
cartridge

75

- 1 or 2 fingers lever
- Rubber injected finger touch
- Ball bearing spindle
- Contactless magnetic trigger system
- Optional battery wireless operation
(requires oXigen cartridge and CRI receiver)
- oXigen compatible (with oXigen cartridge)

SCP201fg

SCP2 electronic controller analog

with Common Ground High Current Cartridge - For all slot cars

Analog controller

SCP-2



SCP201ai
SCP-2 universal analog controller
home racing Replaces SCP201a and SCP201i

76



SCP201f
SCP2 Controller
without Cartridge



SCP201bc
Universal analog cartridge
for SCP-1, SCP-2 and SCP-3
electronic controllers







SCP204a
SCP2 Complete Trigger Set

SCP304a
SCP3 Complete Trigger Set

Electronic controller

Spare parts

- SCP202a 
- SCP202b 
- SCP202e 
- SCP202c 





Complete shell (red, blue, lemon yellow, yellow)



SCP03a 
Complete shell (red)



SCP03b 
SCP03c 
Complete shell
(blue, lemon yellow)

77



SCP302a 
Complete shell (red, blue, lemon yellow, yellow)



SCP04c
Replacement fuses
for SCP 3. 15A - fast (5x)



SCP04e
Spare silicon cable

Analog controller

SCP-2



SCP201d
SCP2 universal digital controller

78



SCP201e
Universal Digital Cartridge



SP32
Spare IR LED on wires
for oXigen and SSD chips



SP15b
**Universal Hornby
SSD upgrade PCB**

Digital controller

SCP-3



SCP301b
Oxygen RF power amplifier
for oXigen system



79

SCP301c
SCP3 power supply cartridge
for oXigen system

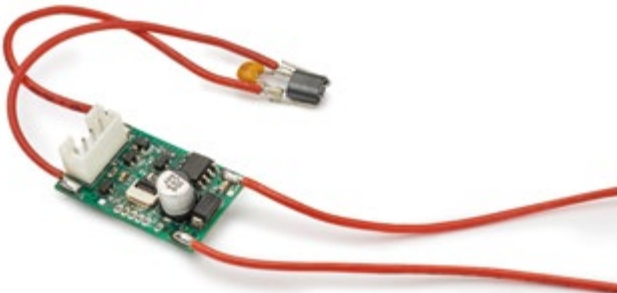

SP43
Universal Carrera digital Chip

oXigen digital system



SCP301a

SCP3 Electronic Controller Analog

with Common Ground High Current Cartridge - for all slot cars

80

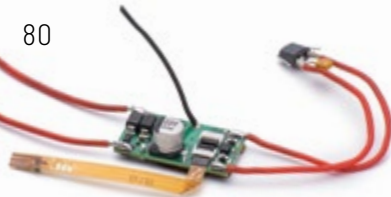

0201c1

oXigen chip in-car controller



0201b2

oXigen chip in-car controller (type B)



0201c-h

Hall sensor



0201c-S04

Bay lid for 0201c chip



0205c

oXigen battery holder/charger (3.6V 1x14500 Li-ion)



0202a

oXigen radio cartridge



SCP201h
SCP2 Digital Controller
oXigen cartridge



0205b
oXigen battery holder



0203a
oXigen lane changer driver
for Ninco/Carrera

81



SP33
Spare Hall sensor
for oXigen chips



SP34
Spare lighting kit
connectors for oXigen chips (3x)



SP32
Spare IR LED on wires
for oXigen and SSD chips



SCP201I
**Electronic universal SCP
radio interface**
Turn your SCP into a wireless
controller for any system

oXigen digital system

Slot racing digital system

Compatible with existing analog tracks,

SSD and Carrera digital *

2.4GHz Wireless, 20 cars per track, up to 2 tracks **

Open PC interface

oXigen ("oxygen" in Catalan language) is the Slot.it system for digital slot racing, supporting up to 20 cars on an unlimited number of lanes, with unmatched features, range, and reliability reflecting many years of development and refinement. It is being used by hundreds of enthusiast racers worldwide, for small home circuits and international 24 hours races as well.

The track remains compatible with analog racing, rails being only used to power the cars and not to transmit control instructions. Lane changing is based on the robust and well tested SSD LED protocol developed by Hornby (used under license), enhanced to include the oXigen specific 'selective lane change' feature. oXigen lane change modules can also work very well with cars chipped with SSD chips. oXigen modules can convert Ninco and Carrera lane changers into oXigen and SSD lane changers, at small cost.

82

oXigen cars can also race on analog traditional tracks, as well as on Scalextric Sport Digital and Carrera Digital 132 systems, as long as they are driven by an oXigen controller[*]. oXigen chipped cars can also be used as 'autonomous self-driving cars' on tracks of all types and makes. Rather than relying on control signals and power coming from the track, oXigen cars receive their control instructions through a high power, frequency hopping 2.4GHz link.

The open PC-dongle protocol for third party software is supported by PCLapCounter and RCS64. Designed, developed, supported by Slot.it, the reference company for slot car racing.

2017 is another exciting year for oXigen: planned are a new, dedicated 2.4GHz SCP controller, an automatic self driving pace car, a very low cost entry level controller, and a further evolution of the in-car chip.

* please read the oXigen user manual for further information on compatibility

** software for two tracks is not yet available

oXigen digital system

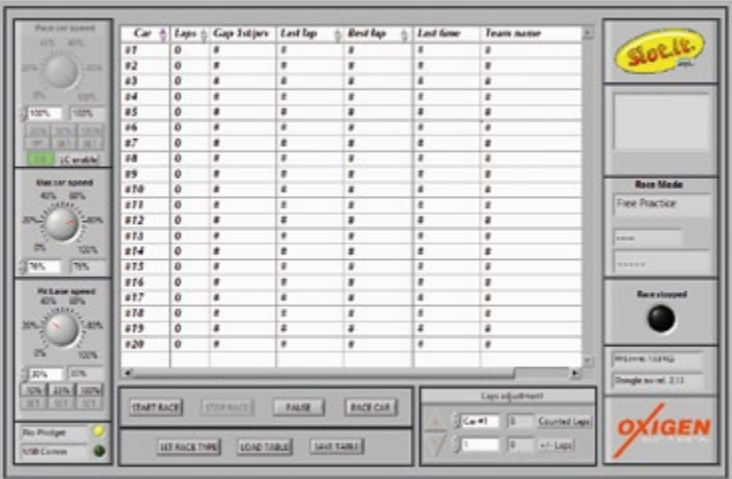

Lane change

- O2 track pieces for Scalextric track O2 LC parts can be used inside Scalextric SSD systems
- (under licence from Hornby) upgrade electronics for Ninco and Carrera lane changers

More oXigen

- A whole new dimension for club slot car racing
- Maintain your existing investment AND analog racing easy setup
- Developed and supported by Slot.it
- Compatible with SCP-1 open PC protocol for third party software
- Supported by PCLapCounter and RCS64
- Available NOW!



O204a
oXigen dongle

Lighting kit



SP11

Lighting kit

2 white front + 2 rear red lights module



SP42

Leds and cables

for lighting kits SP06 and SP16c

84



SP16c

Universal lighting kit

for analogic, SSD Slot.it cars and oXigen



SP26

Switch and mixed electronic parts

for lighting kits SP06 and SP16c



SP44

Universal light kit for analog and digital



Live Timing System

FOR ANY TYPE
OF CONTROLLER

*For further information
concerning the Track
Interface system, see the
relative manual.*



SCP201m

SCP2 Digital Controller oXigen cartridge - Live Timing Box

Live Timing Box is an innovative timing system that allows to:

- reproduce via audio the lap times recorded by the pilot, in a language to be chosen among many;
- store in the device's internal memory the times heard on earphones, sector times and, in case, the telemetry data of the SCP controller of Slot.it to which it is connected;
- listen to your favourite music while driving, by connecting the Live Timing Box to a MP3 player through a normal audio cable not included in the package;
- download the stored data that can be looked up by the user from a PC by means of a special program downloadable for free (we're generous, aren't we?) at www.slot.it (Live Timing Box PC Interface);
- updated the system software, with the opportunity to add new specifications to the Live Timing Box in the future without any additional charge;
- delete stored data (good idea);
- remember the status of data storage button and mute button so that it is not necessary to repeat the setup carried out before the supply was cut off.
- work as a complete Race Management System when used in conjunction with appropriate RMS software (e.g. PCLapCounter).

Moreover, **Live Timing Box** is a versatile system, since its functioning requires only the presence of the **Track Interface** and is **totally independent of the kind of controller employed**.

The presence of the **Track Interface** is necessary since the latter has the job of interfacing the **Live Timing Box** with the track by collecting the signals coming from the sensors on the circuit (DS bridge, dead strips, Winchono,...) and sending them after suitable elaboration to the **Live Timing Box** itself.

Live Timing System

Supported b compatible
wity PC Lap Counterh
DirectlySupport oXigen



TS01a
Live timing box

Programmable
in 10 languages



TS02a
Track interface

87



TS02b
Track to telemetry cable



TS03a
Sector time expansion cable



FREE
Live timing box PC
interface software.

Prints & Posters

88

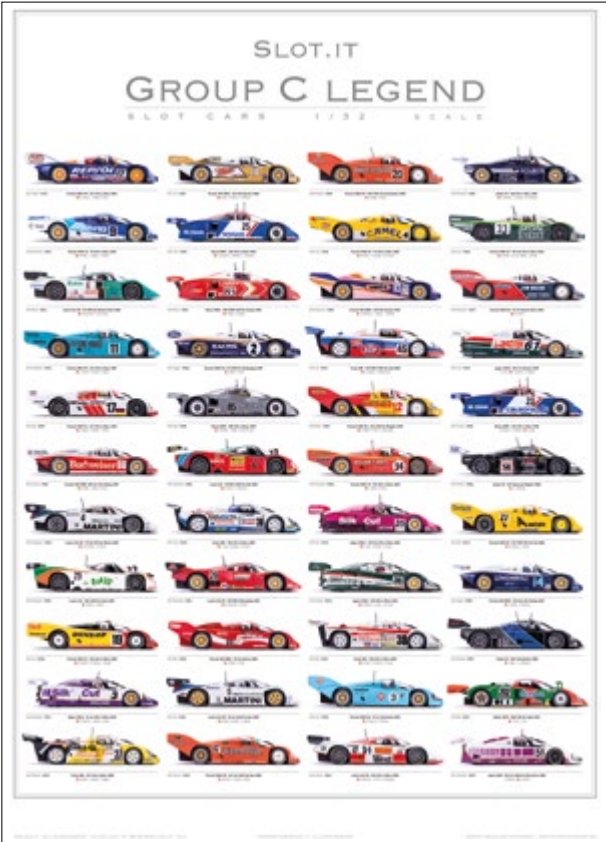

PGRC-2

Poster Slot.it
Group C Legend
(2011-2017)

PGRC-2s

Poster Slot it
Group C Legend
(2011-2017) - signed



Banner

1m Slot.it banner (h 80cm)

Maintenance



SP39
Gear grease
(15g)



SP40
Performance oil
for motors (20ml)



SP41
Motor cleaner
and protector
(50ml)

Packaging



SP09
Transparent box

89



SP36
Clamshell box for 1:32 slot cars



SP35
Plastic spare parts containers
(d.17, h.50 mm)

Distributors

Benelux

Hobbytime BV

Vriezendijk 13
7683 PL DEN HAM
the Netherlands
Tel: 0546 - 53 87 75
Fax: 0546 - 53 88 67
michielpoel@hobbytime.nl

Benelux

Q.U.I.C.K.

Victoria Regiastraat, 32
1338 ZA - Almere
Tel: +31 36 5370853
Fax: +31 36 5370956
fred.quick@upcmail.nl
www.quickholland.com

Brazil

B52 Modelismo

Rua Filinto de Almeida, 96
Santo André - SP
09190-020
Brazil
Tel. +5511 4425 2758
b52grp7@gmail.com
www.b52online.com.br

90

Czech Republic/ Slovakia

SlotRacing.CZ s.r.o.

Tel. +420 475205600
Mob. +420 702910840
shop@slotracing.cz
www.slotracing.cz

France

Fair International

24 rue Pasteur
Za de Ragon
44119 Treillieres
Tel. +33 962 363409
Mob. +33 613 501077
Fax +33 240 592815
fairslot@wanadoo.fr
www.fairslot.com

Germany/ Austria

H+T Motor Racing GmbH

Bert - Brecht - Strasse 43
DE - 64291 Darmstadt
Tel. +49 (0) 6150 84801
Fax +49 (0) 6150 84803
info@ht-motorracing.com
www.ht-autorennbahn.de

Greece

Creative Hobby

17 Vrillission str.
15236 Pendeli, Athens
Greece
Tel./Fax +30 210 6135518
Mob. +30 6977204530
nisko@creativehobby.gr
www.creativehobby.gr

Japan

Ban Project Co. Ltd

412-2 Nippa-cho
Kouhoku-ku, Yokohama,
Kanagawa 223-0057
Japan
Tel. +81-45-834-7673
Fax +81-45-834-7960
bborder@banproject.com
www.banproject.com

Mexico

Slot Club la Pista / Mexico

M. Sotero Prieto 5 A,
Circuito Cientificos
Ciudad Satelite,
Naucalpan de Juarez
México 53100
cel. +52 1 552095 5027
www.slotshoplapista.com

Italy

Galileo Engineering srl

via Cavallotti 16
42122 Reggio Emilia
Italia
Tel./Fax +39 0522 920496
info@slot.it
www.slot.it

Australia

Armchair Racer

1/18-20 Hotham Parade
Artarmon NSW 2064
Australia
Tel. +61 29 906 5566
cathy@armchairracer.com.au
www.armchairracer.com.au

Argentina

Autoslot

Conde 750 - CP 1426
CABA - Buenos Aires,
Argentina
+54 011 45512977
+54 011 45556193
info@autoslot.com
www.autoslot.com

New Zealand P.R.C.

Burmac Ltd

228 Guppy Road
Taradale Napier
4112 New Zealand
Tel +64 6 2110228
admin@burmac.nz
www.slotraceshop.nz

Ju Su Culture

Communication

(Shanghai) Co.LTD

107, No. 671 Hutai Road,
Jing'an District, Shanghai
Tel.+86 13764621213
speed-frontline@qq.com

Singapore

InTrigg Hobbies

62 Ubi Road 1.
Oxley BizHub 2, #05-22.
Singapore 408734.
+65 8222-1330 (WhatsApp)
www.intrigg-hobbies.com
enquiries@intrigg-hobbies.com

South Africa

Redipak Wholesalers

Unit 5, 159 Greenvale Road
Wilbart, Germiston,
1609 Gauteng
Rep. of South Africa
Tel. +27 11 455 5990
Fax +27 86 662 8613
info@redipak.co.za
www.redipak.co.za

Spain/ Portugal

IBG Auto Racing S.L.

C/ La Masia, 26
Pla de les Gavarres
08711 ODENA
Igalada (Barcelona)
Tel. +34 938 030 880
Fax +34 938 055 057
info@ibbautoracing.com
www.ibbautoracing.com

Switzerland

Arwico AG

Brühlstrasse 10
CH-4107 Ettingen
Tel. +41 617221222
Fax +41 617221244
www.arwico.ch

Ors Kart Racing

Avenue des Pâquiers 22
2072 Saint-Blaise
Tel. +41 32 753 02 25
scx@orskartesting.com
www.orskartesting.com

Taiwan

Iron Hero Corp.

No.26, Aly. 24, Ln. 158,
Guoji Rd., Tucheng Dist.,
New Taipei City
236, Taiwan (R.O.C.)
Tel: 886-287321133 /
886932908781
Fax:886-287325232
kenlo@iron-hero.com
www.iron-hero.com

UK / Ireland USA

Gaugemaster Controls Ltd

Gaugemaster House,
Ford Road
Arundel, West Sussex,
BN18 0BN, United Kingdom
Tel. +44 (0)1903 884 321
Fax +44 (0)1903 884 377
www.gaugemaster.com

Hornby America Inc.

4620 95th St SW
Bldg 6, Suite A
Lakewood, WA 98499, USA
Tel. +1 877 358 6405
Fax +1 253 922 7203
info@hornby.us
www.Slotit-USA.com

Stores

Italy

Bigi Modellismo

Via Bernardino Zacchetti, 4,
42124 Reggio Emilia RE
www.bigimodel.it

Bona

Corso IV novembre 69
12042 Bra
Tel. +39 0172 1803241
www.bona.it

Brama Modellismo

Via Giuseppe Minottini 9
06129 Perugia
Tel. +39 075 500 2971
www.bramashop.com

Crazy4Slot

Via del Cigno, 20
61122 Pesaro (PU)
Tel. +39 340 386 7130
www.crazy4slot.com

92

Franchi di Scarpa Giuseppe

Via Padova 74,
20132 Milano
Tel. +39 02 2894967
www.franchidiscarpa.it

Libreria Semola snc

via De Amicis 5D
42025 Cavriago (RE)
Tel. +39 0522 371517
info@libreriasemola.it
www.libreriasemola.it

Modellismo Micro Macro snc

viale del lavoro 47 - 37036
San Martino Buon Albergo (VR)
Tel. +39 045 994554
modellismoveronamicromacro.combusiness.site

Marzi Otello s.a.s.

Piazza Filippo Carli, 19/20
00191 - Roma - RM
Tel: +39 06 3296455
www.slotcars.it

Mularoni Marta Modellismo

Contrada dei Magazzeni 4/6
47890 Centro Storico San Marino,
San Marino
Tel. +39 0549 991211
mularoni-marta-modellismo.business.site

Wonderland Pavia Gilpavia srls

Via Pietro Nenni, 72/a,
27100 Pavia PV
Tel. +39 0382 460809
wonderland-pavia.business.site

Canada

Mini Grid Inc.

549 Mt. Pleasant Road
Toronto, Ontario, Canada
4S 2M5
Phone: (416) 488-7663
smaxwell@minigrd.com
www.minigrd.com

Denmark

LP-Sales v/Per Springborg

Bakkevej 12
DK-5450 Otterup
Phone: (+45) 61553016
lp-sales@mail.dk
www.dk-minirace.dk

Odsherreds Slot Car Shop

Tigervej 2
4581 Rørvig
Denmark
info@oscs.dk
Facebook: oscs.dk
www.oscs.dk

Scalextric-shop.dk

Fredensborgvej 41,
DK-3400 Hillerød
Phone: Jan: 24215808 - Per: 21734483a
info@scalextric-shop.dk
www.scalextric-shop.dk

SlotWorld.dk

Racefun ApS.
Roskildevej 14
DK-2620 Albertslund
Phone: (+45) 29 919191
mail@slotworld.dk
www.slotworld.dk

Sweden

AGICO AB

Sandgatan 10
247 62 VEBERÖD
SWEDEN
Phone: +46 730 584 995
info@slotcar4fun.se
www.slotcar4fun.se